

Common Features:

- Apertures accepting a wide range of busbar size.
- Easy Busbar Mounting.
- CT's are ultrasonically welded and are unbreakable.
- Terminals are finger touch proof for safety
- Highly Cost effective.
- Compact in size.

Specification:

System Voltage	720 V maximum	Saturation coefficient	< 5
Test Voltage	3kV for 1minute	Insulation Class	Class E
System Frequency	50 Hz or 60 Hz	Secondary terminals	M5 Screw clamps
Primary ratings	From 200A to 3000A	Operating Temperature	-20° C to +70° C
Secondary outputs	5A is standard; 1A on request	Humidity	< 95% RH (non condensing)
Short circuit thermal Current (Ith)	60 x Rated primary current for 1 sec	Enclosure	Flame retardant glass filled ABS
Over load withstand	1.2 times rated current continuously	Compliance with	VE 404 and IEC185 / IEC61869
Rated dynamic Current	2.55 x Ith	Mounting hardware	Feet and Busbar screws



Outer Dimension :
61 (W) x 78.5 (H) x 30 (D)

Models	VIPS 30102630								VIPS 30182630								VIPS 40122630								
Accuracy	Class 1				Class 0.5				Class 1				Class 0.5				Class 1								
Ratio (A)	Burden (VA)				Burden (VA)				Burden (VA)				Burden (VA)				Burden (VA)								
50/5 A	1																								
75/5	1	1.5							1	1.5															
80/5		1.5	2.5							1.5	2.5														
100/5		1.5	2.5			1.5	2.5			1.5	2.5			1.5	2.5		1	1.5							
150/5		1.5	2.5			1.5	2.5			1.5	2.5			1.5	2.5			1.5	2.5						
200/5		1.5	2.5	5		1.5	2.5	5		2.5	5			2.5	5	10		1.5	2.5						
250/5		1.5	2.5	5	10		1.5	2.5	5	10		2.5	5	10		2.5	5	10		1.5	2.5	5			
300/5		1.5	2.5	5	10		1.5	2.5	5			2.5	5	10		2.5	5	10		1.5	2.5	5			
400/5		1.5	2.5	5	10		2.5	5	10		2.5	5	10		2.5	5	10		1.5	2.5	5				
500/5			2.5	5	10		2.5	5	10		2.5	5	10		2.5	5	10		1.5	2.5	5	10			
600/5		1.5	2.5	5	10		2.5	5	10		2.5	5	10	15		2.5	5	10	15		1.5	2.5	5	10	
750/5			2.5	5	10		2.5	5	10		2.5	5	10	15		2.5	5	10	15			2.5	5	10	15
800/5																				2.5	5	10	15		

Bus Bar Dimension

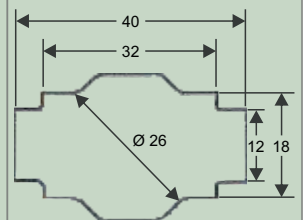
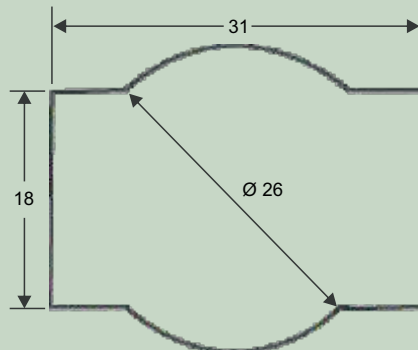
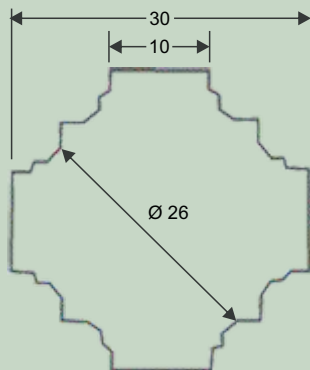



Outer Dimension :
71 (W) x 88.5 (H) x 40 (D)

Models	VIPS 20102040				VIPS 40103240				VIPS 40123040									
	Class 1		Class 0.5		Class 1		Class 0.5		Class 1		Class 0.5							
Ratio (A)	Burden (VA)		Burden (VA)		Burden (VA)		Burden (VA)		Burden (VA)		Burden (VA)							
30/5	1																	
40/5	1.5																	
50/5	1.5	2.5		1.5	1.25	1.5			1.25	1.5								
60/5	1.5	2.5	5	1.5	1.25	1.5			1.25	1.5								
75/5		2.5	5	2.5	1.5	2.5			1.5	2.5								
80/5		2.5	5	2.5	1.5	2.5			1.5	2.5								
100/5		2.5	5	10	2.5	5	1.5	2.5	3.75	1.5	2.5	1.5						
125/5		2.5	5	10	2.5	5	1.5	2.5	5									
150/5		5	10	2.5	5	2.5	5	10	1.5	2.5	5	1.5	2.5					
200/5		5	10	15	2.5	5	2.5	5	10	1.5	2.5	5	2.5	5	10			
250/5		5	10	15	5	10	2.5	5	10	1.5	2.5	5	1.5	2.5	5			
300/5							2.5	5	10	15	2.5	5	10	15	2.5	5		
400/5							2.5	5	10	15	2.5	5	10	15	2.5	5	10	
500/5		2.5	5	10	15	2.5	5	10	15	2.5	5	10	15	2.5	5	10	15	
600/5		2.5	5	10	15	2.5	5	10	15	2.5	5	10	15	2.5	5	10	15	
750/5		5	10	15	5	10	15	30	5	10	15	5	10	15	30	5	10	15
800/5		5	10	15	30	5	10	5	10	15	30	5	10	5	10	15	30	
1000/5		5	10	15	30	5	10	15	30	5	10	15						

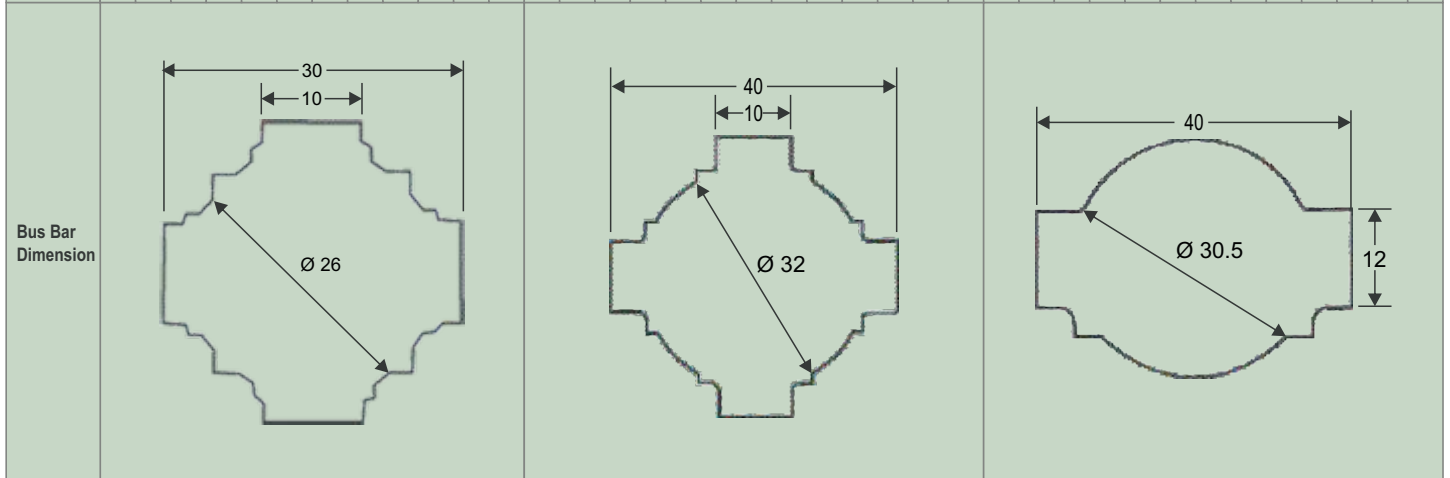



Outer Dimension :
96 (W) x 108.5 (H) x 40 (D)

Models	VIPS 63104460												VIPS 80105580												VIPS 100308510													
Accuracy Ratio (A)	Class 1 Burden (VA)				Class 0.5 Burden (VA)				Class 1 Burden (VA)				Class 0.5 Burden (VA)				Class 1 Burden (VA)				Class 0.5 Burden (VA)																	
200/5	1.5	2.5			1.5	2.5																																
250/5	1.5	2.5			1.5	2.5																																
300/5	1.5	2.5	5		1.5	2.5	5																															
400/5	1.5	2.5	5	10	1.5	2.5	5	10		2.5	5			2.5	5	10		2.5	5	10		2.5	5	10			2.5	5	10	15	30							
500/5	1.5	2.5	5	10	15	2.5	5	10	15	2.5	5	10		2.5	5	10		2.5	5	10		2.5	5	10			2.5	5	10									
600/5		2.5	5	10	15	2.5	5	10	15	2.5	5	10		2.5	5	10		5	10			2.5	5	10														
750/5		2.5	5	10	15	2.5	5	10	15	2.5	5	10	15	2.5	5	10	15		5	10			5	10														
800/5		2.5	5	10	15	2.5	5	10	15	2.5	5	10	15	2.5	5	10	15	5	10	15			5	10														
1000/5			5	10	15	30	5	10	15	30	2.5	5	10	15	30	5	10	15		5	10	15	30		5	10		5	10									
1200/5			5	10	15	30	5	10	15	30	5	10	15	30	5	10	15		5	10	15	30		5	10		5	10										
1250/5			5	10	15	30	5	10	15	30	5	10	15	30	5	10	15		5	10	15	30		5	10		5	10										
1500/5			5	10	15	30	5	10	15	30	5	10	15	30	45	5	10	15		5	10	15	30	45	5	10		5	10	15								
1600/5			5	10	15	30	5	10	15	30	5	10	15	30	45	5	10	15		5	10	15	30	45	5	10		5	10	15								
1800/5																																						
2000/5															10	15	30	45		10	15																	
2400/5																																						
2500/5																																						

Bus Bar Dimension

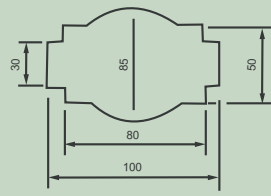
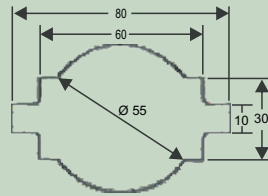
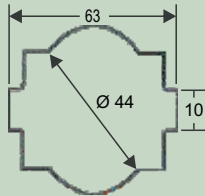

Outer Dimension :
129 (W) x 170 (H) x 40 (D)

Models	VIPS 60304460												VIPS 80166180												VIPS 10055510														
Accuracy Ratio (A)	Class 1 Burden (VA)				Class 0.5 Burden (VA)				Class 1 Burden (VA)				Class 0.5 Burden (VA)				Class 1 Burden (VA)				Class 0.5 Burden (VA)																		
400/5																																							
500/5													2.5	5					2.5	5	10																		
600/5	1.5	2.5			1.5	2.5			2.5	5	10			2.5	5	10		2.5	5	10		2.5	5	10			2.5	5											
750/5		2.5	5		2.5	5			2.5	5	10			2.5	5	10		5	10			2.5	5	10															
800/5			5	10		5			2.5	5	10	15		2.5	5	10	15		5	10			5	10				5	10										
1000/5			5	10	15		5	10		2.5	5	10	15		2.5	5	10	15		5	10			5	10			2.5	5	10	15								
1200/5			5	10	15		5	10	15	2.5	5	10	15	30		5	10	15		5	10	15		5	10	15			5	10	15								
1250/5			5	10	15		5	10	15	5	10	15	30		5	10	15		5	10	15		5	10	15			5	10	15	30								
1500/5			5	10	15		5	10	15	5	10	15	30		5	10	15		5	10	15		5	10	15	30		5	10	15	30								
1600/5			5	10	15		5	10	15	5	10	15	30	45	5	10	15		5	10	15		5	10	15	30	45	5	10	15	30								
1800/5			5	10	15		5	10	15	5	10	15	30	45	5	10	15		5	10	15		5	10	15	30	45	5	10	15	30								
2000/5			5	10	15		5	10	15																			10	15	30	45								
2400/5			5	10	15		5	10	15						10	15	30	45		10	15																		
2500/5			5	10	15		5	10	15																			10	15	30	45								
3000/5			5	10	15		5	10	15																			10	15	30	45								

Bus Bar Dimension

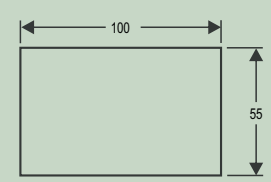
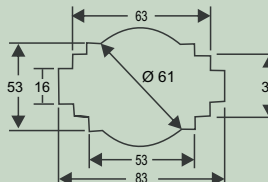
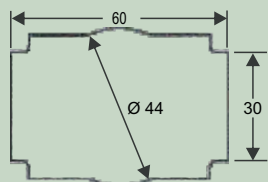

Common Features:

- Apertures accepting a wide range of busbar size.
- Easy Busbar Mounting.
- CT's are ultrasonically welded and are unbreakable.
- Terminals are finger touch proof for safety
- Highly Cost effective.
- Compact in size.

Specification:

System Voltage	720 V maximum	Saturation coefficient	< 5
Test Voltage	3kV for 1minute	Insulation Class	Class E
System Frequency	50 Hz or 60 Hz	Secondary terminals	M5 Screw clamps
Primary ratings	From 50A to 4000A	Operating Temperature	-20° C to +70° C
Secondary outputs	5A is standard; 1A on request	Humidity	< 95% RH (non condensing)
Short circuit thermal Current (Ith)	60 x Rated primary current for 1 sec	Enclosure	Flame retardant glass filled ABS
Over load withstand	1.2 times rated current continuously	Compliance with	VE 404 and IEC185 / IEC61869
Rated dynamic Current	2.55 x Ith	Mounting hardware	Feet and Busbar screws



MODEL-301

MODEL	RATIO	CLASS	1 VA	2.5 VA	5 VA
301-60/5A	60/5A	CLASS	3	-	-
301-75/5A	75/5A	CLASS	3	-	-
301-80/5A	80/5A	CLASS	3	-	-
301-100/5A	100/5A	CLASS	1	-	-
301-125/5A	125/5A	CLASS	1	-	-
301-150/5A	150/5A	CLASS	1	3	-
301-200/5A	200/5A	CLASS	-	1	-
301-250/5A	250/5A	CLASS	-	1	-
301-300/5A	300/5A	CLASS	-	1	3
301-400/5A	400/5A	CLASS	-	-	1
301-500/5A	500/5A	CLASS	-	-	1
301-600/5A	600/5A	CLASS	-	-	1

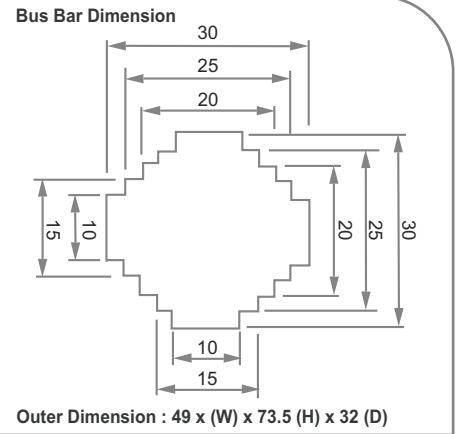

MODEL-401

MODEL	RATIO	CLASS	2.5 VA	5 VA	7.5 VA
401-150/5A	150/5A	CLASS	3	-	-
401-200/5A	200/5A	CLASS	1	-	-
401-250/5A	250/5A	CLASS	1	-	-
401-300/5A	300/5A	CLASS	1	3	-
401-400/5A	400/5A	CLASS	-	1	3
401-500/5A	500/5A	CLASS	-	0.5	1
401-600/5A	600/5A	CLASS	-	0.5	1
401-750/5A	750/5A	CLASS	-	0.5	1
401-800/5A	800/5A	CLASS	-	0.5	1

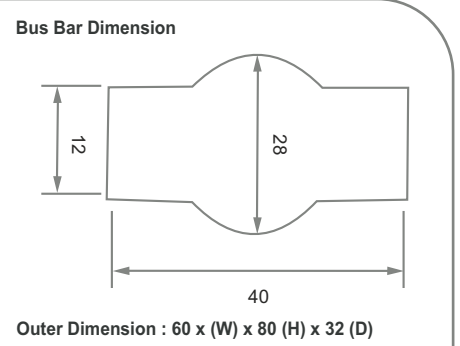

MODEL-501

MODEL	RATIO	CLASS	10 VA
501-125/5A	125/5A	CLASS	0.5
501-150/5A	150/5A	CLASS	0.5
501-200/5A	200/5A	CLASS	0.5
501-250/5A	250/5A	CLASS	0.5
501-300/5A	300/5A	CLASS	0.5
501-400/5A	400/5A	CLASS	0.5

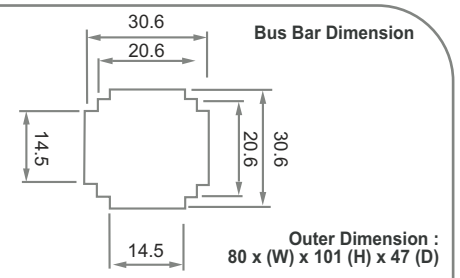

MODEL-3301

MODEL	RATIO	CLASS	1.25 VA	2.5 VA	5 VA	10 VA
3301-50/5A	50/5A	CLASS	3	-	-	-
3301-60/5A	60/5A	CLASS	1	-	-	-
3301-75/5A	75/5A	CLASS	1	-	-	-
3301-80/5A	80/5A	CLASS	1	-	-	-
3301-100/5A	100/5A	CLASS	-	-	1	-
3301-125/5A	125/5A	CLASS	-	-	1	-
3301-150/5A	150/5A	CLASS	-	-	1	-
3301-200/5A	200/5A	CLASS	-	-	1	-
3301-250/5A	250/5A	CLASS	-	-	-	1
3301-300/5A	300/5A	CLASS	-	-	-	1
3301-400/5A	400/5A	CLASS	-	-	-	1
3301-500/5A	500/5A	CLASS	-	-	-	1
3301-600/5A	600/5A	CLASS	-	-	-	1
3301-750/5A	750/5A	CLASS	-	-	-	1

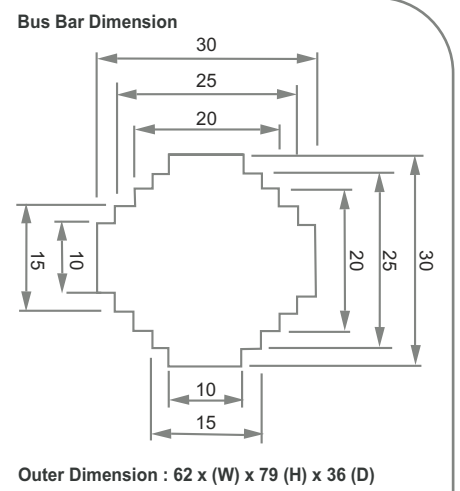



MODEL-4401

MODEL	Class 1	
	Burden (VA)	
4401-150/5A	2.5	
4401-200/5A	2.5	
4401-250/5A	2.5	
4401-300/5A		5
4401-400/5A		5
4401-500/5A		5
4401-600/5A		5
4401-750/5A		5
4401-800/5A		5

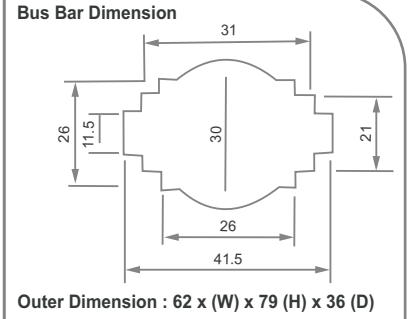

MODEL-601

MODEL	Class 1		Class 0.5		
	Burden (VA)		Burden (VA)		
601-200/5A	2.5				
601-250/5A	2.5	5			
601-300/5A	2.5	5			
601-400/5A	2.5	5	10		
601-500/5A	5	7.5	15	10	
601-600/5A	5	10	15	10	
601-750/5A	5	10	15	10	
601-800/5A	5	10	15	10	
601-1000/5A	10	15	15	10	15
601-1200/5A	10	15	30	10	15
601-1250/5A	10	15	30	10	15
601-1500/5A	10	15	30	10	15
601-1600/5A	10	15	30	10	15

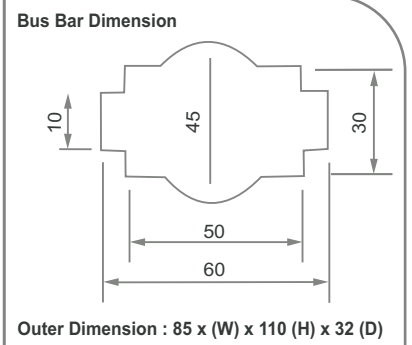

MODEL-801

MODEL	Class 1		Class 0.5	
	Burden (VA)		Burden (VA)	
801-400/5A	2.5	5	5	
801-500/5A	2.5	5	7.5	5
801-600/5A	2.5	5	10	5
801-750/5A	2.5	5	10	10
801-800/5A	5	7.5	10	10
801-1000/5A	5	7.5	10	10
801-1200/5A	5	7.5	10	10
801-1250/5A	5	7.5	10	10
801-1500/5A	5	10	15	10
801-1600/5A	5	10	15	10
801-2000/5A	5	10	15	10

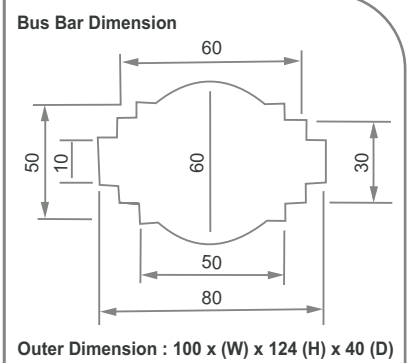

MODEL-1001

MODEL	Class 1		Class 0.5		
	Burden (VA)		Burden (VA)		
1001-400/5A	5				
1001-500/5A	5				
1001-600/5A	5	10	10		
1001-750/5A	5	10	10		
1001-800/5A	5	10	10		
1001-1000/5A	5	10	10	15	
1001-1200/5A	5	10	15	10	15
1001-1250/5A	5	10	15	10	15
1001-1500/5A	5	10	15	10	15
1001-1600/5A	5	10	15	10	15
1001-2000/5A	5	10	15	10	15
1001-3000/5A	5	10	15	10	15
1001-4000/5A	5	10	15	10	15

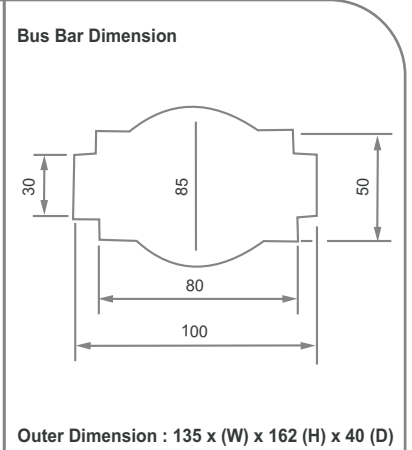

MODEL-1020

MODEL	Class 1		Class 0.5	
	Burden (VA)		Burden (VA)	
1020-750/5A	10		10	
1020-800/5A	10		10	
1020-1000/5A	10		15	
1020-1200/5A	10		15	
1020-1250/5A	10		15	
1020-1500/5A	15		15	
1020-1600/5A	15		15	
1020-2000/5A	15		15	
1020-2500/5A	15		15	
1020-3000/5A	15		15	

